

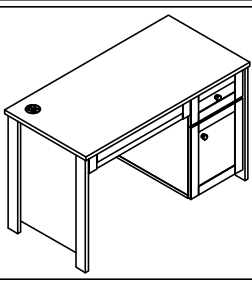















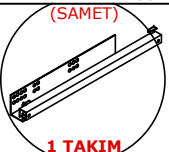

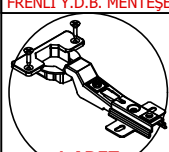
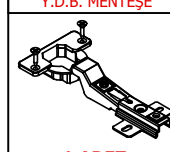

orpak®

GRUP : OSLO
GROUP : OSLO
ÜRÜN : ÇALIŞMA MASASI
PRODUCT : WORKTABLE
RENK : BEYAZ
COLOUR : WHITE

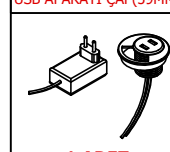
KOD : 2142
CODE : 2142

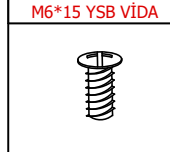

AKSESUAR LİSTESİ / ACCESSORIES LIST

ACCESSORIE NO : 001 MİNİFİK MİL 6 MM  6 ADET	ACCESSORIE NO : 002 TİTUS MİNİFİK GÖVDE  24 ADET	ACCESSORIE NO : 317 10'LUK MİNİFİK MİL  18 ADET	ACCESSORIE NO : 004 Ø8x30 KAVELA  20 ADET	ACCESSORIE NO : 020 MİNİFİK TAPA  8 ADET
ACCESSORIE NO : 351 TANDEM RAY 400 (SAMET)  1 TAKIM	ACCESSORIE NO : 120 6.3*13 MM EURO VİDA  11 ADET	ACCESSORIE NO : 406 PLS. RAF PİMİ EURO VİDALI  7 ADET	ACCESSORIE NO : 172 ÇİFT AÇILIMLI 350mm RAY  1 TAKIM	ACCESSORIE NO : 113 3.5*18 MM S. VİDASI  8 ADET
ACCESSORIE NO : 105 M6*30 VİDA  4 ADET	ACCESSORIE NO : 184 FRENLİ Y.D.B. MENTEŞE  1 ADET	ACCESSORIE NO : 023 Y.D.B. MENTEŞE  1 ADET	ACCESSORIE NO : 092 4*18 MM S. VİDASI  8 ADET	ACCESSORIE NO : 495 USB APARATI ÇAP(59MM)  1 ADET
ACCESSORIE NO : 481 OSLO TEKLİ KULP  2 ADET	ACCESSORIE NO : 246 M4*30 MM VİDA  12 ADET	ACCESSORIE NO : 114 M6*15 YSB VİDA  1 ADET	ACCESSORIE NO : 273 SOLERO AYAK  1 ADET	ACCESSORIE NO : 011 ARKALIK SABİTLEME 3.5x25 S.VİDASI  5 ADET
ACCESSORIE NO : 104 M4*25 MM VİDA  2 ADET				

YEDEK AKSESUAR SİPARİŞLERİNİ RESME BAKARAK VERİNİZ. (Örn:ACCESSORIE.NO:008 - RAFIX MİL - 1 Ad.)
PLEASE ORDER THE ACCESSORIES ACCORDING TO THE REFERENCE NUMBER ON THE DRAWING(EXAMPLE ACCESSORIE NO-008 RAFIX MIL 1.PCS.)

orpak®

PARÇA LİSTESİ PARTS LIST

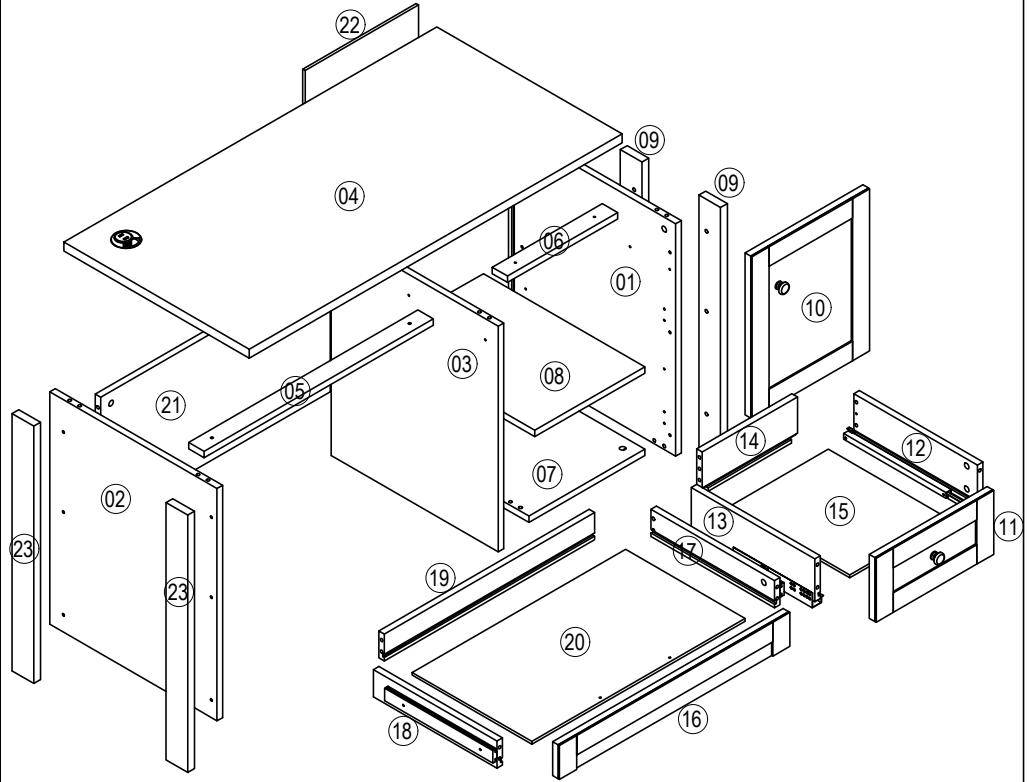

FR-002

NO	ADET/PCS	NO	ADET/PCS	NO	ADET/PCS
01	1	11	1	21	1
02	1	12	1	22	1
03	1	13	1	23	2
04	1	14	1		
05	1	15	1		
06	1	16	1		
07	1	17	1		
08	1	18	1		
09	2	19	1		
10	1	20	1		

YEDEK PARÇA SİPARİŞLERİNİ RESME BAKARAK PARÇA NUMARASINA GÖRE VERİNİZ
PLEASE ORDER THE SPARE PARTS ACCORDING TO THE REFERENCE NUMBER ON THE DRAWING