

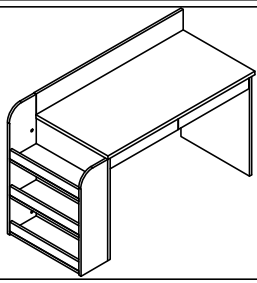









orpak®

GRUP : JOY IN-2
GROUP : JOY IN-2
ÜRÜN : ÇALIŞMA MASASI
PRODUCT : WORK TABLE-2
RENK : AYTAŞI & KAPUÇİNO
COLOUR : MOONSTONE & CAPPUCCİNO

KOD : 1222
CODE : 1222

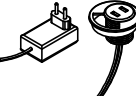

AKSESUAR LİSTESİ / ACCESSORIES LIST

ACCESSORIE NO : 317 10'LUK MINİFİX MİL  29 ADET	ACCESSORIE NO : 002 TİTUS MINİFİX GÖVDE  37 ADET	ACCESSORIE NO : 004 Ø8x30 KAVELA  26 ADET	ACCESSORIE NO : 172 ÇİFT AÇILIMLI 350mm RAY  2 TAKIM	ACCESSORIE NO : 113 3.5*18 MM S. VİDASI  16 ADET
ACCESSORIE NO : 097 4*45 S. VİDASI  3 ADET	ACCESSORIE NO : 020 MINİFİX TAPA BEYAZ  15 ADET	ACCESSORIE NO : 200 RAF PİMİ EURO VİDALI  2 ADET	ACCESSORIE NO : 120 6.3*13 MM EURO VİDA  2 ADET	ACCESSORIE NO : 001 MINİFİX MİL 6 MM  8 ADET
				ACCESSORIE NO : 495 USB APARATI ÇAP(59MM)  1 TAKIM

YEDEK AKSESUAR SİPARİŞLERİNİ RESME BAKARAK VERİNİZ. (Örn:ACCESSORIE.NO:008 - RAFİX MİL - 1 Ad.)
PLEASE ORDER THE ACCESSORIES ACCORDING TO THE REFERENCE NUMBER ON THE DRAWING(EXAMPLE ACCESSORIE NO-008 RAFİX MIL 1.PCS.)

orpak®

PARÇA LİSTESİ PARTS LIST

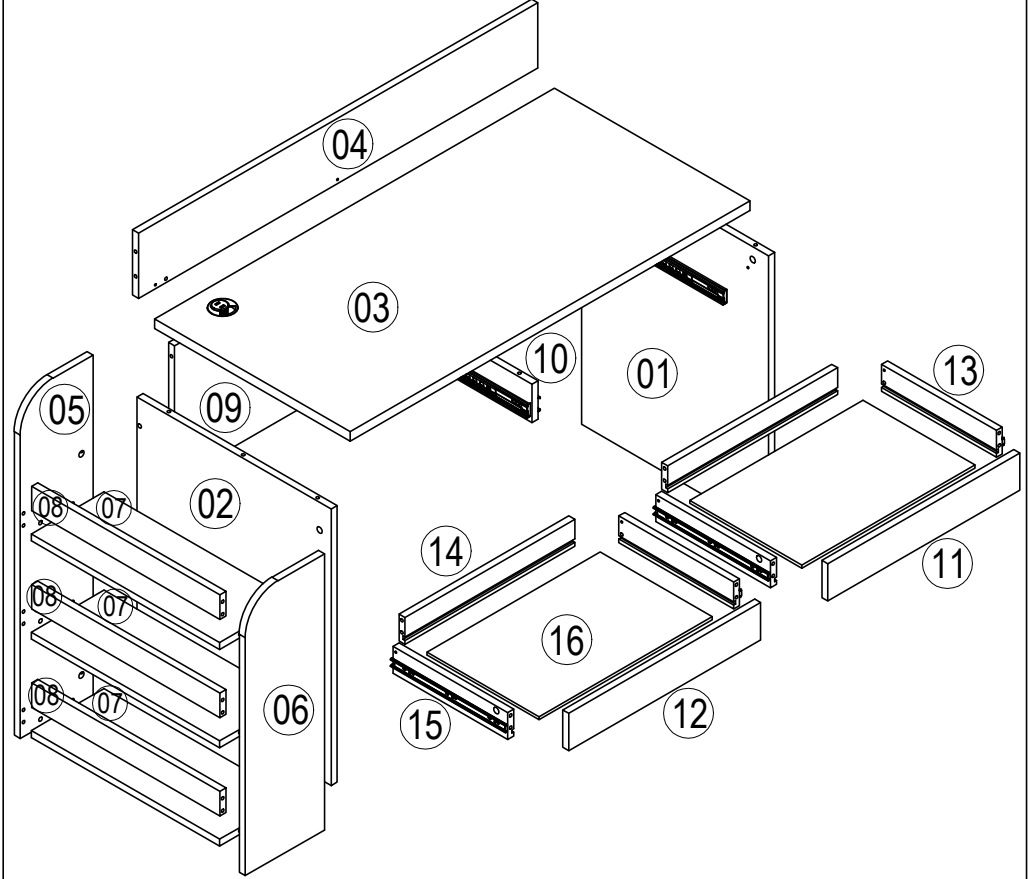

FR-002

NO	ADET/PCS	NO	ADET/PCS	NO	ADET/PCS
01	1	11	1		
02	1	12	1		
03	1	13	2		
04	1	14	2		
05	1	15	2		
06	1	16	2		
07	3				
08	3				
09	1				
10	1				

YEDEK PARÇA SİPARİŞLERİNİ RESME BAKARAK PARÇA NUMARASINA GÖRE VERİNİZ
PLEASE ORDER THE SPARE PARTS ACCORDING TO THE REFERENCE NUMBER ON THE DRAWING

